

THE
GENERAL RADIO

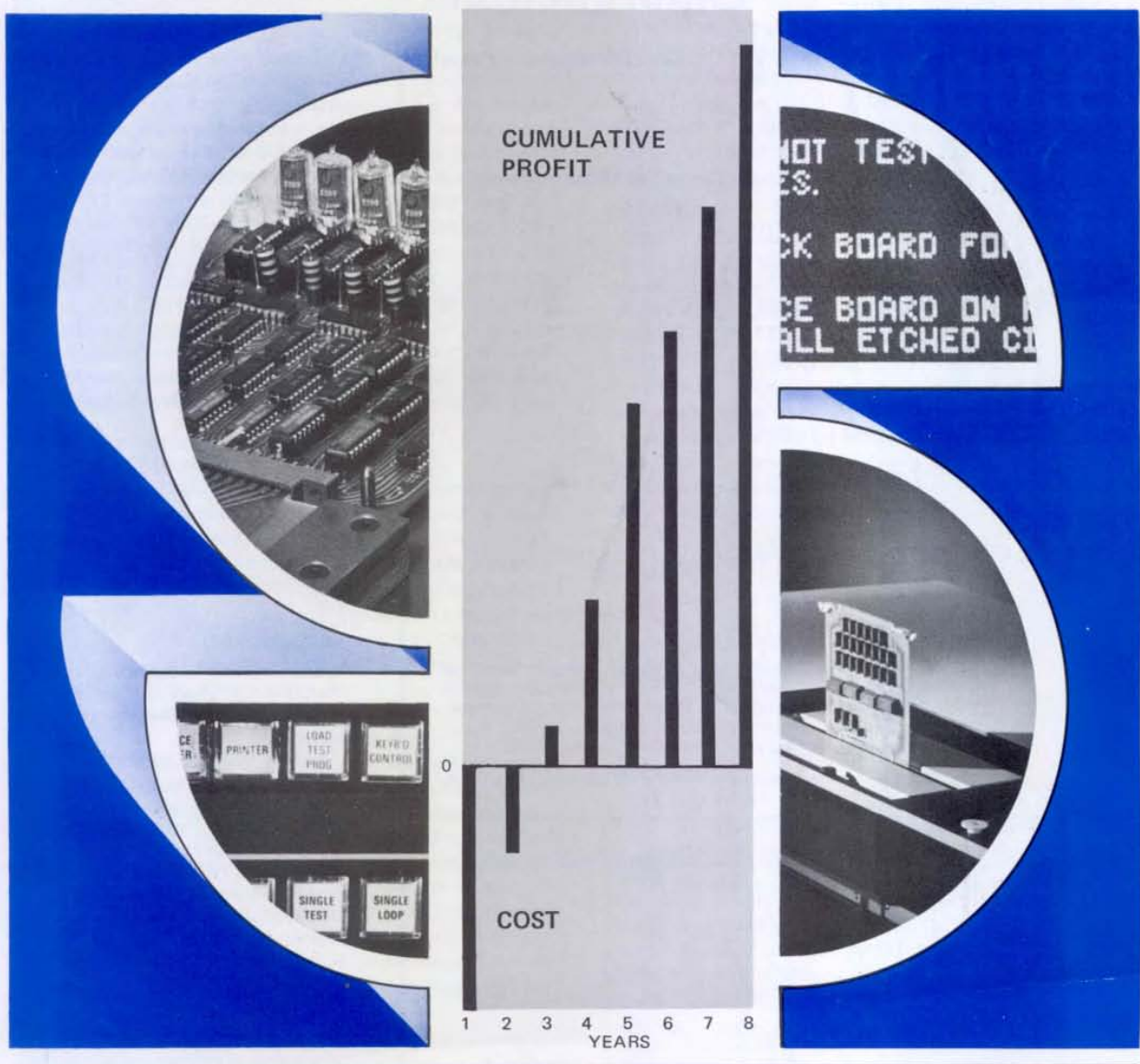

Experimenter

VOLUME 44
NUMBERS 1, 2
JANUARY/FEBRUARY 1970



IET LABS, INC in the **GenRad** tradition
534 Main Street, Westbury, NY 11590

www.ietlabs.com
TEL: (516) 334-5959 • (800) 899-8438 • FAX: (516) 334-5988

THE
GENERAL RADIO 
Experimenter

VOLUME 44 NUMBERS 1, 2 JANUARY/FEBRUARY 1970

The Economy of Computer-Controlled Measurements. 3

"The old order changeth . . ." 6

GR 1790 Logic-Circuit Analyzer 7

Synthesizing at Higher Frequencies 10

The *General Radio Experimenter* is mailed without charge to engineers, scientists, technicians, educators, and others interested in the instruments and techniques of electrical and electronics measurements. Address all correspondence to Editor, *General Radio Experimenter*, General Radio Co., West Concord, Mass. 01781.

© 1970 - General Radio Company, West Concord, Mass., USA

THE COVER should indicate to all readers that General Radio has proved the profitability of investing in a computer-controlled logic-circuit tester.

According to a forecast by the U.S. Department of Labor, issued early in 1970, the services and skills of engineers and technicians will continue to be in heavy demand during the next decade. The rate of growth of demand conceivably can be twice that of all working people.

The department foresees a shortage in supply of this critical group because of the decreasing enrollment in engineering studies. A determined effort must be made on the part of industry to upgrade all technical and semi-technical personnel to provide more efficient performance, thereby helping to close the gap between manpower needs and manpower accomplishments.

At the risk of stating the obvious, we would like to stress to our readers and their managers the need also to upgrade the use of machines and the *machines* themselves, releasing the human beings for more essential planning and thinking tasks. It is for this very reason that companies like General Radio recently have been devoting much of their research, innovation, and development talents to the production of automatic test equipment that will relieve technical personnel from repetitive and tedious tasks. This will permit more constructive and efficient use of their capabilities.

There is another basic reason for using machines: *Profit*. Industry finds that many applications of machine control to routine tasks save money, after the short period of time required to earn back (in most applications) the original capital investment in tooling. Too often, however, the men with the strongest instinct to do things better, faster, and more efficiently do not have sufficient background in finance to convince management of the ultimate wisdom of spending money, and sometimes lots of it, for machine assistance. It is to them we have addressed the first article in this issue.

Through the years of teaching fellow workers the ways to approach management for capital funds, we have found no better way than to present the proposal in terms of the probability of payback in a comparatively short time with realizable profits following immediately. We hope that you will be able to apply this principle to your own procurement problems.

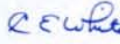
C. E. White
Editor



IET LABS, INC in the **GenRad** tradition
534 Main Street, Westbury, NY 11590

www.ietlabs.com
TEL: (516) 334-5959 • (800) 899-8438 • FAX: (516) 334-5988

The Economy of Computer-Controlled Measurements*

Introduction

Is your production schedule limited by manual tests of items completed or in process? Have you noticed that your inspection people are unable to retain efficiency as they routinely and monotonously check, check, check? Perhaps you've begun to give some thought toward changing your test methods, revising or replacing your old test equipment, and improving the efficiency of your inspectors. The idea of employing computer-assisted test equipment has been in your mind for some time but you don't know how to justify, to a hard-nosed management, the costs of the added facilities.

Your problem is no different from that which faced our production engineers at General Radio some time ago, when they decided to change from manual to computerized production-test operations. We thought, therefore, that a short discussion of the technique used by the engineers to convince GR management to finance the change would be of interest and value to our readers. The examples given use current cost and test-rate data and are presented for different quantities of digital logic boards to illustrate the application of the technique.

Why Economic Considerations?

The *engineering* decision to use costly test instrumentation is not very difficult since it is usually based upon technical considerations only. The *financial* decision, however, is usually made by an entirely different group of people, continually alert to the material needs and operating costs of an organization. Because of the ability of technical and financial minds to cross-fertilize each other and to reach a common understanding, progressive industrial organizations originated a rational approach to capitalization of facilities several years ago. They named it "cost-effectiveness" and it became a useful management tool. More important, it forced production engineers, in need of test equipment, to speak the language of accountants and broadened the appreciation each had for the other. Engineers began to speak in terms of total investment, discounted rate of return, depreciable life and tax shields. Accountants became equally appreciative of component failures and failure rates, of labor time to maintain equipment and to inspect production components, of equipment interfaces and software, and of precision of tolerances.

Another advantage of this cross-fertilization of ideas was to change the focus of management's attention from what *has*

been invested in equipment to what *should be* invested in equipment. Yesterday's investment decision resulted in savings we are experiencing today, but can a new investment today result in even greater savings tomorrow?

These terms and techniques are illustrated below as they might be used to calculate a cost-effectiveness solution to the problem of testing digital logic boards. Our solution was the GR 1790 Logic-Circuit Analyzer.¹ The typical data used are based upon experience with GR logic circuits constructed with 12 to 60 14- or 16-pin digital IC's on printed-circuit boards.

The Old Way

Prior to the installation of the GR 1790 system in our manufacturing facility, we used hard-wired test fixtures for each board to be tested. Preparation of these fixtures required a design and fabrication period of 1 to 4 weeks per board, normally averaging 2 weeks. Test times using these fixtures were reasonably short (5 to 10 minutes), but the lack of significant diagnostic information resulted in troubleshooting and repair times of 20 to 40 minutes.

Total costs for this approach are shown below, assuming the minimum times given above, a quantity of 10,000-boards/year made up of 50 different board types, and a board failure rate of 33%.

WITH ORIGINAL TEST FIXTURES	
Preparation:	
(50 types/yr) (2 wk/type) (40 h/wk) (\$4/h)	\$16,000
Test:	
(10,000 bd/yr) (5 min/bd) ($\frac{1}{60}$ h/min) (\$4/h)	3,333
Troubleshooting and Repair:	
(3,333 rejects/yr) (20 min/bd) ($\frac{1}{60}$ h/min) (\$4/hr)	4,444
Total	\$23,777

The Forecast

Our production engineers estimated that, after introduction of a computer-controlled test system, preparation of the test programs and test fixtures would take 24 hours per board type. Actual test time per board, by relatively unskilled labor, would be 30 seconds. Since rejected boards would be accompanied by a troubleshooting printout from the computer, time to diagnose and to repair the rejects was expected to decrease from 20 minutes to 12 minutes.

*As applied to procurement and application of the GR 1790 Logic-Circuit Analyzer, described on page 7.

¹Fichtenbaum, M. L., "Computer-Controlled Testing Can Be Fast and Reliable and Economical without Extensive Operator Training," *Electronics*, January 19, 1970.



Based upon these estimates, costs (in 1968) were calculated:

WITH COMPUTER-CONTROLLED TEST SYSTEM

Preparation:		
(50 types/yr) (24 h/type) (\$4.00/h)		\$4,800
Test:		
(10,000 bd/yr) (30 s/bd) ($\frac{1}{60 \times 60}$ h/s) (\$1.65/h)	138	
Troubleshooting and Repair:		
(10,000 X .33 bd/yr) (12 min/bd) ($\frac{1}{60}$ h/min) (\$4.00/h)	2,640	
	Total	\$7,578

Hence the total direct-labor savings made possible by use of the computer-controlled test system were estimated to be \$23,777 - \$7,578 = \$16,199/year. Management approved the installation after reviewing these figures and studying a funds-flow analysis similar to that of Tables 3 and 4.

The New Era

Use of the 1790 Logic-Circuit Analyzers in the manufacturing facilities confirmed the production engineers' forecast. The preparation time was significantly reduced, since only a simple mechanical interface and an easy-to-write test program were required for each new device. These are normally prepared in 1/2-2 days depending upon the complexity of the board to be tested and, in our experience, averaged 1 day/type. The actual test time was reduced to milliseconds, but the time required to insert and remove the board being tested kept the total test time at an average of 30 seconds. The GR 1790 makes convenient the inclusion of diagnostic suggestions in the test program so that troubleshooting time may also be reduced. The time required, however, to effect a repair (replace an IC, remove a solder bridge, etc) kept the troubleshooting/repair time to an average of 6 minutes. Actual total costs for the same quantities used in the forecast to management are

WITH THE GR 1790 LOGIC-CIRCUIT ANALYZER

Preparation:		
(50 types/yr) (1 d/type) (8 h/d) (\$4/h)		\$1,600
Test:		
(10,000 bd/yr) (30 s/bd) (1/3600 h/s) (\$2/h*)	167	
Troubleshooting and Repair:		
(3,333 rejects/yr) (6 min/reject) ($\frac{1}{60}$ h/min) (\$4/h)	1,333	
	Total	\$3,100

*Relatively unskilled labor cost - 1969.

Table 1
Typical Annual Labor Savings
(Based on GR experience)

Bd/yr	10% Reject			50% Reject		
	50	100	500	50	100	500
1,000	\$14,800	\$29,200	\$124,400	\$15,200	\$29,600	\$144,800
10,000	18,500	32,900	148,100	22,200	37,600	151,900
100,000	55,400	69,800	185,000	92,700	107,100	222,300

Hence, the total direct-labor savings made possible by the GR 1790 in this example are \$23,777 - \$3,100 = \$20,677/year.

The typical quantities (and hence the labor savings) will obviously differ with industry and product. Table 1 gives the value of annual labor savings for 3 quantities of boards, 3 numbers of different types of boards, and 2 failure percentages. These figures are based upon the same rates used in the preceding example.

The saving in labor costs is only one calculation in the cost-effectiveness approach. It is also important to consider the expenses and savings over a period of time of concern (the cash flow) and to discount future funds to reflect their present value.**

The obvious initial expense is the purchase price of the system. Additional costs include time spent attending training courses and acquiring proficiency in writing test programs and using the system, plus normal operation and maintenance costs.

The labor savings calculated above are reduced by the 50% Federal corporate tax rate, as are other internal expenses and savings. Included on the savings side of the ledger is depreciation, a non-cash expense that acts as a tax shield. Analysis of the depreciation of the GR 1790 appears in Table 2.

Table 3 gives the funds-flow analysis for an eight-year period. The Net Operating Advantage is shown at the bottom of each column. Table 4 presents an analysis of the funds-flow after taxes for the same eight-year period. It is obvious from Table 1 that use of a larger number of different types of boards or a larger quantity of boards would significantly affect the final calculation. For example, if this study had been based on 100 different types of boards instead of 50, the Payback Period would have been about 8 months and the Discounted Rate of Return would have been approximately 150%.

**The application of accounting principles, which reflects the time value of money.

Table 2
Depreciation Calculation for GR 1790
(Sum-of-the-years-digits method)

Year	Digits	Depreciation	50% Tax Shield
Original cost:		\$32,500	
Salvage:		-4,000	
Useful life:	8 years		
Depreciable cost:		\$28,500	
1969	8/36	\$ 6,300	\$ 3,150
1970	7/36	5,500	2,750
1971	6/36	4,700	2,350
1972	5/36	4,000	2,000
1973	4/36	3,200	1,600
1974	3/36	2,400	1,200
1975	2/36	1,600	800
1976	1/36	800	400
		\$28,500	\$14,250



Table 3
Funds-Flow Analysis – Type 1790

	1969	1970	1971	1972	1973	1974	1975	1976
EXPENSES								
Cash Outlay (Purchase)	\$32,500	\$ —	\$ —	\$ —	\$ —	\$ —	\$ —	\$ —
Cash Inflow (Salvage)	—	—	—	—	—	—	—	(4,000)
Production Engineering \$1000 first year, \$500 there- after (50% tax shield)	500	250	250	250	250	250	250	250
Maintenance	500	500	500	500	500	500	500	500
Total Expenses	33,500	750	750	750	750	750	750	(3,250)
SAVINGS								
Test/Repair Labor Savings (50% Tax Shield)	10,338	10,338	10,338	10,338	10,338	10,338	10,338	10,338
Depreciation (50% Tax Shield from Table 2)	3,150	2,750	2,350	2,250	1,600	1,200	800	400
Total Savings	13,488	13,088	12,688	12,338	11,938	11,538	11,138	10,738
NET OPERATING ADVANTAGE	(\$20,012)	\$12,338	\$11,938	\$11,588	\$11,188	\$10,788	\$10,388	\$13,988

Table 4
Funds-Flow After Taxes

Year	Annual	Cumulative	Payback Ratio
1969	(\$20,012)	(\$20,012)	—
1970	12,338	(7,674)	—
1971	11,938	4,264	0.13
1972	11,588	15,852	0.49
1973	11,188	27,040	0.83
1974	10,788	37,828	1.16
1975	10,388	48,216	1.48
1976	13,988	62,204	1.91

Payback Period = 2.6 years

Discounted Rate of Return = 56%

A standard discount table was used to calculate the Discounted Rate of Return, which was 56%. This percentage can be related to a corporate goal for return on investment to screen out undesirable projects or programs.

Alternatively, an arbitrarily chosen discount rate, which approximates the desired internal rate of return, can be used to discount the cash flows. The Present Value of a project is the sum of the discounted cash flows; a positive Present Value indicates a profitable project. The magnitude of Present Value of a project can be related to that of other projects to allow management to make a choice between programs competing for available funds.

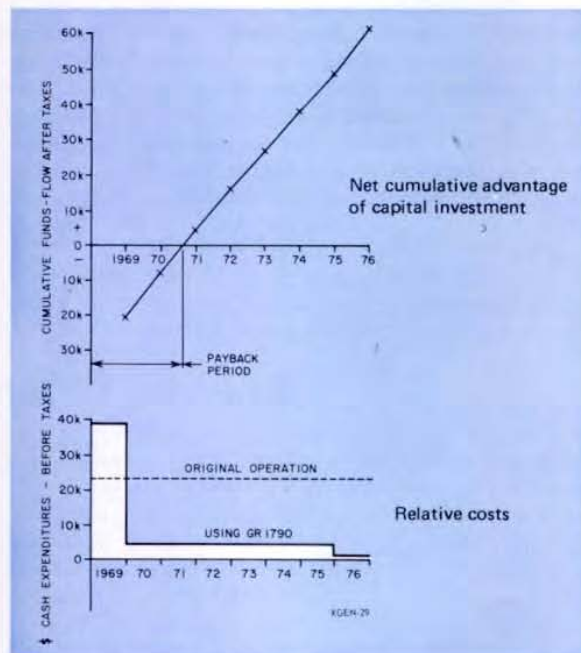

For those of you who are not familiar with cash flow discounting we offer a short explanation. We have referred to the time value of money. Because of this factor, expenses (cash outflows) of one period of time cannot be directly compared with income (cash inflows) of another period. The reason for this is that the money we have today can be invested to bring us a return and, therefore, will be worth more at the end of this year, next year, and each succeeding year that the money remains invested. At a discount rate of 10%, \$1 earned three

years from now is worth, to us today, \$1/\$1.33 or \$.75. That is the Present Value of the \$1 earned three years hence: \$.75. The discount rate chosen is usually the desired *internal rate of return*.

Further information is available to readers interested in financial aspects of facility acquisition in a reprint of a talk by W. D. Hill of General Radio to the Planning Executives Institute, October 4, 1968, entitled "Planning Investments in Research and Development."

Other Applications

At General Radio, the GR 1790 is also used in Incoming Inspection for functional tests of all digital IC's. This inspection has reduced our failure rate of IC's in printed circuit boards from an initial 4-8% to less than 1%. Were these figures included in the cost-effectiveness analysis, the case for the GR 1790 would be even stronger. We did not, however, include these figures in the above example since the primary purpose of the GR 1790 is to test and troubleshoot assembled logic boards, and because relatively low-cost digital IC testers are available. On the other hand, the increasing use of MSI and LSI circuits in standard 16- and 24-pin packages has created additional testing requirements that cannot be met by low-cost digital IC testers. The ease with which the GR 1790 makes these tests assures ready customer acceptance even in its IC testing role. And, of course, printed circuit boards that use many of these MSI packages are in turn so much more complex that the reduction in test and troubleshooting time provided by the GR 1790 far exceeds the savings depicted in the examples above.

Views of the Manufacturing Manager

The planning and foresight of the production engineers were justified on the basis of simple dollars-and-cents analyses, before and after the fact. Consequently, their view of the world through rose-colored glasses could be excused. But what about the manufacturing manager, close to the assembly line and continually alert to every-day personnel relationships? His reactions to the system were expressed somewhat like this: **The test system, like any expensive tool, had to meet a number of basic requirements. It did. These included ease of operation by normally skilled machinists/technicians.**

The system was completely useful almost from the moment of installation – familiarization/training time was a minimum. The test capability of the system was broad, sufficient to permit change of interface equipment from component testing to assembly testing within a very short period of time. Vendor service, such as programming advice or advice on instrumentation implementation, was continually available from knowledgeable sources.

The position of the manufacturing manager at GR is not necessarily the same as that of a manufacturing manager at another company. In this case, however, a true vendor-customer relationship existed because of the complexity of design and application problems. Consequently, the solutions to the personnel-interface problems between manufacturing and engineering were worked out smoothly and, in fact, became the basis for the program of service decided upon to implement the sales of the system to industry at large.

Conclusion

In many ways, our experience in development and application of the GR 1790 supports the theme that innovative metrology is, in fact, the key to industrial progress.* Industry can gain immeasurably by new ways of saving time and reducing costs and by new technologies and their applications.

*The theme of the 1970 Standards Laboratory Conference, sponsored by the National Conference of Standards Laboratories, is "Innovative Metrology – Key to Progress."

The Editor is indebted for most of the material contained in this article to P. H. Goebel, R. E. Anderson, and R. F. DeBoalt. Financing details were verified and expanded upon by W. D. Hill.

"The old order changeth . . ."

As companies grow, old patterns tend to change. Our International Division is currently growing at a rapid pace; we are progressively assuming a more and more direct role in our sales abroad, and old marketing relationships are dissolving.

In Europe we are establishing our own sales subsidiaries, and we have taken over from old and valued friends the job of selling and servicing GR products. Thus, in 1964, we established General Radio Company (U.K.), Limited and said good-bye to Claude Lyons, Limited after 27 years. As of the middle of 1969 we purchased the GR segment of Etablissements Radiophon, our French outlet for over 33 years, and rechristened it General Radio France, with Paul Fabricant temporarily staying on as President to ease the transition.

In setting up our new subsidiary, General Radio Italia S.p.A., and bidding farewell to Ing. S. and Dr. Guido Belotti S.r.l., we again bring to a conclusion a long and fruitful collaboration. Dr. Belotti, and his father before him, represented us in Italy for 37 years and will continue to manufacture, under GR license, Variac® autotransformers.

We have expanded the coverage of our German subsidiary, General Radio GmbH, to the northern part of Germany as well as the southern. This brought to a close a shorter association with Dr.-Ing. G. Nüsslein but one that has helped significantly to expand GR's market in Germany.

In Latin America we have worked for 29 years through the export house of Ad. Auriema, Inc. In furthering our objective of establishing as direct contact as possible with our customers, we are now moving one step closer to them by replacing this channel by a network of representatives directly responsible to GR. To Carlos Auriema, who, with his father before him, has been our colleague and friend, we must now say goodbye.

These gentlemen – Claude Lyons, Paul Fabricant, Dr. Guido Belotti, Dr. Günter Nüsslein, and Carlos Auriema – have all been good friends, as well as business associates, of GR. We wish them well in their continuing pursuits and thank them for their contributions to General Radio's successes.

– D.B. Sinclair

GR 1790 LOGIC-CIRCUIT ANALYZER*



GR 1790 DEFINED

The GR 1790 Logic-Circuit Analyzer is a computer-controlled functional GO/NO-GO and diagnostic test system for logic devices ranging from basic 14-pin integrated circuits to assemblies with as many as 96 inputs and 144 outputs. The system performs up to 4000 tests per second and yields a GO/NO-GO indication and a typewritten or scope-displayed error message.

Purchase justification is easy.** Savings are stressed in the process of programming and in the ready adaptability of test fixtures. Test programs are written by technician-level personnel in much less time than it takes to write manual test procedures, and costly tooling is eliminated by the simple and flexible device adaptor between the tester and the tested. Testing costs are low because of the speed of computer-directed tests, and troubleshooting costs can be sharply reduced by the inclusion of operator diagnostic instructions in the test program.

The simplified test language developed by General Radio can be learned in just a few hours. The entire test operation is characterized by speed and efficiency:

1. The operator writes a test program consisting of simple statements of the

input and output conditions of the circuit to be tested.

2. The test program is converted to punched tape on the teletypewriter and then is automatically translated into a more compact form; programming errors are detected during the translation.

3. The test program is entered into the computer via the high-speed tape reader.

4. The test circuit is connected to the system by a device adaptor corresponding to the input/output configuration of the circuit.

5. The operator presses the START button on the control panel.

All testing then proceeds automatically. Should a fault occur, the operator can troubleshoot immediately or continue to test the remainder of the devices, saving the repair work for later.

The five steps above apply only when a new test program is required. If the test operator receives a new manufacturing run of a previously tested device only steps 3, 4, and 5 will be needed, thereby enhancing the speed and savings features of the GR 1790.

THE PHYSICAL ORDER

The standard system components of the GR 1790 are:

- Computer with 4,096 12-bit words of 1.6- μ s-cycle core memory.
- Interface system.
- Control panel.

- Power supplies.
- Teletypewriter with keyboard, tape reader, and tape punch.
- Photoelectric tape reader.
- Alpha-numeric display oscilloscope.
- Logic probe.
- Device adaptor kits.

Options include a rack version, additional memory, and programmable logic levels.

In both desk console and rack versions, all controls are within easy reach and monitoring indicators are readily visible (Figure 1). The GR 1790 does not

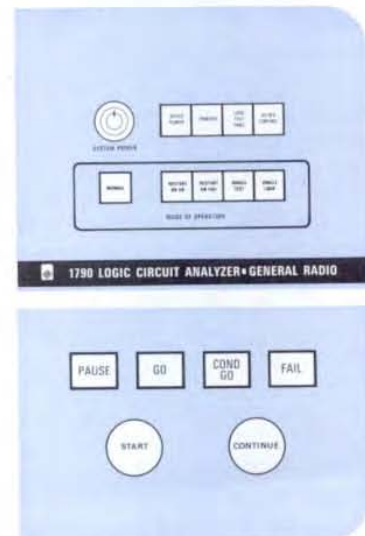

Figure 1. Control panel layout.

* Abstracted from special brochure available upon request.

** See page 3.

require a special, controlled environment.

Costly tooling, test fixtures, and documentation are eliminated since each circuit to be tested requires only a device adaptor and a test program. The device adaptor accommodates most physical configurations of test circuits and is locked in place in a recess in the top of the console. Adaptors, provided with wire-wrap pins on etched boards, can be wired with a variety of connectors and can include additional control functions, loads, logic-level conversions, or any other circuitry necessary for the application at hand.

GR 1790 TEST LANGUAGE

A high-level test language enables the user of the analyzer to write test programs without requiring a knowledge of computer programming. This language is described in detail in the special brochure. A few of the many features of this test language are noted below:

Autoprogramming

It is not necessary to program the output logic states of the device to be tested. The GR 1790's Autoprogramming feature enables a known good reference device to provide this information to the system. After automatically double-checking these outputs (against a second known good reference device, if desired), the computer stores them as a permanent part of the test program. Hence, no reference device need be kept on hand during the actual testing.

Automatic Generation of Tests

By definition, only completely combinational logic may be tested with an arbitrary pattern of input stimuli. Such logic circuitry may require as many as 2^n tests for a device with "n" inputs. The GR 1790 SEQUENCE statement eliminates all the effort in test programming by automatically generating a sequence of tests with all combinations of the specified inputs. The outputs of a "known good" reference device are stored by the Autoprogramming feature described above. Use of the SEQUENCE statement results in an extremely simple program (A).

Diagnostics

The GR 1790 test language facilitates inclusion of diagnostic informa-

A

```
*I(1,2,3,5,11,4,7,10,12,6,9,8) /INPUT SPECIFICATION STATEMENT
*O(43,44,61,69,82) /OUTPUT SPECIFICATION STATEMENT
SEQUENCE(3,5,1,2,7,12,11,10,4,8,6,9) /STATEMENT WHICH AUTOMATICALLY
/GENERATES A SEQUENCE OF 4,096
/TESTS WITH ALL COMBINATIONS OF
/THE LISTED INPUTS
END /END OF PROGRAM
```

B

```
*I(1,13,5,81,7,19) /INPUT SPECIFICATION STATEMENT
*O(1,2,37,62,69,71,49,50) /OUTPUT SPECIFICATION STATEMENT
1;IH(1,5,7)IL(13,81,19)$ /SET INPUTS 1, 5, AND 7 HIGH AND 13, 81,
/AND 19 LOW; DON'T CHECK OUTPUTS ($)
IGNORE(#37,62) /IGNORE "ALL BUT" (#) OUTPUTS 37 AND 62
IF(37)2 /IF OUTPUT 37 IS HIGH AND 62 IS LOW (DESIRED
/RESULT) TRANSFER TO TEST 2
PRINT CHANGE IC 14! /INCORRECT RESULT, SO DISPLAY A MESSAGE
/TO OPERATOR ON SCOPE
PAUSE 1 /SYSTEM PAUSES
2;IL(1)OL(#) /LOWER INPUT 1 AND TEST THAT ALL OUTPUTS
/ARE LOW
.
.
.
.
33;IH(13,5)IL(#13,5)$ /SET INPUTS 13 AND 5 HIGH AND ALL BUT 13
/AND 5 LOW
IGNORE (#69,71,49,50,2) /IGNORE ALL BUT THESE OUTPUTS
IF (#69)34 /IF ALL BUT OUTPUT 69 ARE HIGH AND 69 IS
/LOW, TRANSFER TO TEST 34
CALL 70 /CALL DIAGNOSTIC SUBROUTINE BEGINNING
/ON TEST 70 AND RETURN HERE
34; /NEXT TEST
.
.
.
DO 53,100 /DO LOOP WHICH REPEATS THE NEXT TEST
/THROUGH TEST 53 ONE HUNDRED TIMES
/DESIRED SEQUENCE OF INPUTS TO BE REPEATED
50;IH(1)$
51;IH(13)$
52;IL(1)$
53;IL(13)$
.
.
.
.
70;$ /DUMMY TEST - BEGINNING OF SUBROUTINE
PRINT ATTACH IC CLIP /DIAGNOSTIC ROUTINE USES OPERATOR
TO IC34, THEN /INTERVENTION
PRESS CONTINUE!
PAUSE 59 /SYSTEM PAUSES
71; /DIAGNOSTIC ROUTINE
.
.
78;
RETURN /PROGRAM RETURNS TO LOCATION FROM WHICH
/IT WAS CALLED
END
```

tion in the test program. When failures occur, the program can transfer to diagnostic routines or display messages to the operator suggesting possible remedies. Some examples of diagnostic tests and other test-language features are contained in sample program B.

THE END RESULT

Tests of circuit boards at GR's West Concord facility serve as examples of applications of the features described on the preceding pages. The fact that these boards (and many others like them) are now being tested in volume on the GR 1790 and incorporated into other GR instruments is testimony to the speed, economy, and effectiveness of the Logic-Circuit Analyzer.

The first sample board, Figure 2, with 10 inputs and 6 outputs, consists of 40 integrated circuits and 22 discrete components (functionally, two 12-bit binary counters, one 24-bit recognition circuit, and six state-recognition circuits). The programming time required for this board was 12 hours. Device-adaptor preparation involved only wiring of a blank adaptor, which took 30 minutes. The test program consisted of 293 test statements plus loops that brought the total number of tests to 30,000. The total test time was about 7 seconds.

The following examples are brief looks at other circuits of varying complexity.

The board in Figure 3 has 26 inputs and 26 outputs assigned to its logic portion. The logic itself is simply 35 inverters contained within 7 IC's. Program-

ming time: 30 minutes. Device-adaptor preparation time: 30 minutes to wire a blank adaptor. Test statements: 25. Total test time: 10 milliseconds.

The next example, Figure 4, has 11 inputs and 18 outputs, and consists of 27 IC's and 5 discrete components (functionally, decoders, a 3-bit binary counter, a 14-bit flip-flop shift register with parallel output, and 15 read-in gates). Programming time: 8 hours. Device-adaptor preparation time: 30 minutes to wire a blank adaptor. Test statements: 151 (with loops, the total board check consists of 293 tests). Test time: 80 milliseconds.

The final example, Figure 5, is a front-panel assembly consisting of 7 BCD-to-decimal converters, 7 decimal display tubes, six 10-position thumb-wheel switches, 24 dpdt pushbutton switches, an 8-position rotary switch, and a dpdt toggle switch. The panel has 32 inputs and 63 outputs. Programming time: 8 hours. Device-adaptor fabrication time: 8 hours to wire a blank adaptor and to construct special cables from panel to adaptor. Test statements: 188. Test time: 3 minutes, including time for the operator to reset controls on the assembly, according to scope-displayed instructions.

Leading parts in the design of the GR 1790 prototype system were played by R. T. Cvitkovitch, M. L. Fichtenbaum, A. W. Winterhalter, and C. Lynn, with R. G. Fulks and D. S. Nixon, Jr. acting in advisory capacities. Development of the version described in the article primarily rested upon the shoulders of Fichtenbaum, P. A. d'Entremont, P. H. Goebel, and J. B. Pennell.

Complete specifications for the GR 1790 are in GR Catalog U, available shortly, and in a special brochure available on request.

Description	Price in USA
1790 Logic-Circuit Analyzer, console version	\$32,500.00
Option 1 Rack Version	(no extra charge)
Option 2 Additional Memory	add 11,500.00
Option 3 Programmable Logic Levels	add 9,500.00
1790-9601 Device Adaptor Kit, without holes for socket, 72 inputs-72 outputs	110.00
1790-9602 Device Adaptor Kit, without holes for socket, 96 inputs-144 outputs	160.00
1790-9603 Device Adaptor Kit, with holes for socket, 72 inputs-72 outputs	115.00
1790-9604 Device Adaptor Kit, with holes for socket, 96 inputs-144 outputs	165.00

All prices subject to quantity discount.

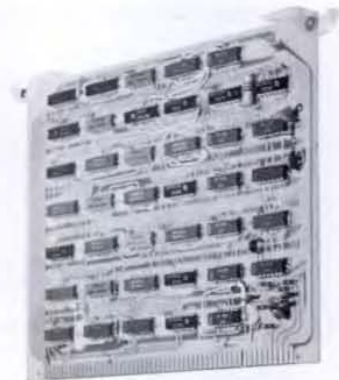

Figure 2. Test time: 7s for 30,000 tests.

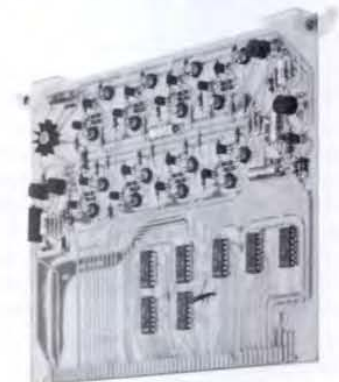

Figure 3. Test time: 0.010s/board.



Figure 4. Test time: 0.080s/board.

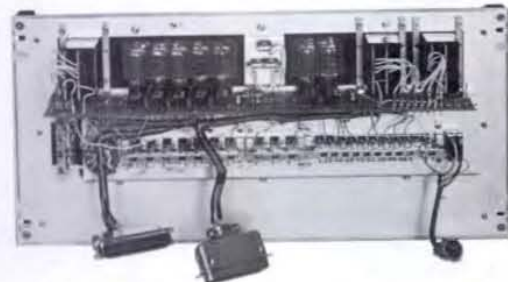

Figure 5. Test time (including control reset): 3 min.

SYNTHESIZING AT HIGHER FREQUENCIES



1165 Frequency Synthesizer

A Bit of Philosophy

The constant pressure of competitive enterprise doesn't encourage complacency in the market place these days. If we mention that the midnight lamps glow frequently at GR, it's not a joke! Our design engineers take their projects in dead seriousness and are under constant pressure to innovate or to improve the existing GR line of instruments. The smiling faces our readers see on the photographs of engineer-authors within the pages of the *Experimenter* usually reflect the pleasant sense of accomplishment when a project is complete. The ultimate test of completion, however, is *acceptance* of the new product by the public, based upon technical performance and *economic cost*.

Cost to the consumer has weighted industrial design considerations very heavily during the past few years and shows promise of even more influence in the decade of the 1970's. With these facts in mind, it is pleasant to announce the availability of another GR instrument, designed for the economy-minded customer. The technical description of the GR 1165 Frequency Synthesizers, which follows, does not emphasize its low cost to any great extent — if our readers are impressed by the specifications and features of this synthesizer, the price information at the end of this article will be a pleasant surprise.

A Bit of Information

The frequency synthesizer is the universal signal source for all applications requiring accurate programmable frequencies. Typical is heterodyning the synthesizer output with another signal carrying intelligence for transmission via radio frequencies or applying the intelligence directly as phase modulation

to the synthesizer.¹ The synthesizer can be employed as a heterodyning oscillator for a radio receiver or it can be the driving source for impedance or transmission characteristic measurements in a computer-controlled automatic test system. The synthesizers are ideal for measurement of signal-source stability, and they have found extensive application in nuclear magnetic resonance studies.

The new GR 1165 Frequency Synthesizers extend to 159.9999 MHz the frequency coverage of the GR 1160 series previously announced. The units are remotely programmed by use of BCD coding and are supplied in master and slave versions.

The master unit contains a precision quartz-crystal master oscillator, opera-

ting in a temperature-controlled oven, and can be locked to an external frequency standard for greater precision, if desired. A front-panel warning light signals failure to lock to an external source. Provision is made on the master unit for maintaining power to the crystal oven by means of an external battery, in the event of ac power failure.

The slave unit requires an external frequency driving source, provided by the auxiliary 10-MHz output of a master unit or any other precision 5- or 10-MHz source. Each slave unit also has an auxiliary 10-MHz output derived directly from its input; this permits any number of slave units to be cascaded if the first unit in the chain is driven by an external source.

Fundamentals of the derivation of the synthesizer output have been described previously.² In the GR 1165 units, one oscillator uses a 3-decade scale-of-“N” phase-lock loop to provide 1000 steps of frequency selection. This technique provides considerable savings in space and production costs as compared with the previously used technique of a single decade of control per locked oscillator.

A Review of Some Characteristics

- Locally or remotely controlled, from 10kHz to 159.9999MHz in 100-Hz steps.

¹“Applications for Coherent Decade Frequency Synthesizers,” GR reprint Form No. 3218-A, available upon request to the Editor.

²Noyes, A., Jr., “Coherent Decade Frequency Synthesizers,” *GR Experimenter*, September 1964.

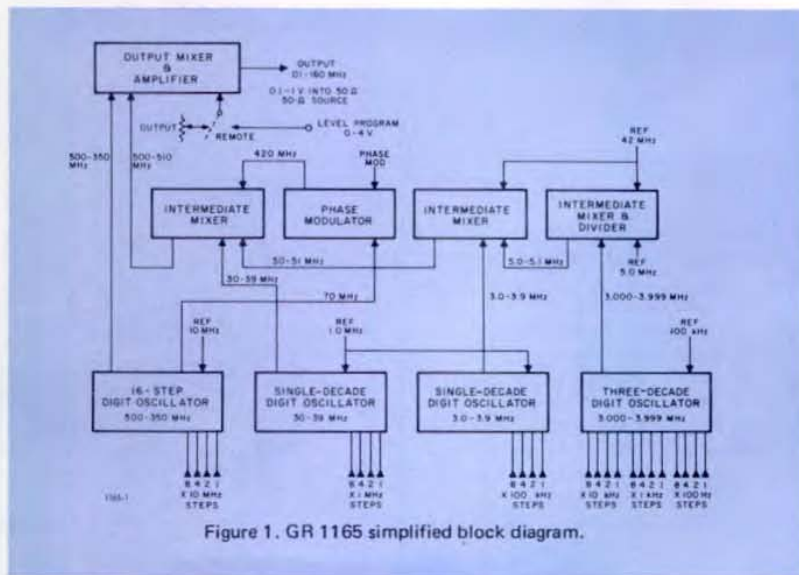

Figure 1. GR 1165 simplified block diagram.

- Auxiliary outputs at 1 MHz and 10 MHz.
- Logic levels are +5 V for logic "0" and +0.5 V or less for logic "1," to facilitate interconnection with other GR instrumentation logic controls.
- All program lines maintain logic "0" unless the external circuit is grounded. A maximum current of 3 mA to ground is required to program a logic "1." These logic levels are compatible with external DTL or TTL IC gates or inverters; a simple external change, using IC inverters, adapts the unit to positive logic-level circuits.
- Externally controlled frequency selection uses 1-2-4-8 binary coded control.

- Can be phase modulated up to ± 3 radians at rates from dc to 300 kHz, up to ± 1 radian at 1 MHz.
- Continuously energized quartz-crystal-oscillator oven maintains master-oscillator stability of $< 2 \times 10^{-10}$ per degree Celsius in 0° to 50° C environment and $\approx 1 \times 10^{-9}$ stability per day after one-month continuous operation.
- Physical height of relay-rack models is only 3½ inches.

— W. F. Byers

The GR 1165 development was by an engineering team consisting of W. F. Byers, C. C. Evans, G. H. Lohrer, R. L. Moynihan and P. L. Sullivan, assisted by A. E. Carlson and R. J. Hanson, and headed by A. Noyes, Jr., Group Leader.



After graduating from Ohio State University with a BSEE degree, W. F. Byers joined General Radio in 1943 as a development engineer. Presently, he is Group Leader in the GR Signal-Generator Group. He is a Senior Member of IEEE and is registered as a professional engineer in Massachusetts.

Complete specifications for the GR 1165 appear in GR Catalog U, available shortly.

Catalog Number	Description	Price in USA
1165-9720	1165 Frequency Synthesizer, master version	Bench
1165-9721		Rack
1165-9722	1165 Frequency Synthesizer, slave version	Bench
1165-9723		Rack

All prices subject to quantity discount.



NEW

The trend toward miniaturization of test equipment is exemplified by the new GR 1436 Decade Resistors, available in two values: 111,110 Ω and 1,111,100 Ω , with smallest steps of 1 Ω and 10 Ω respectively. In addition, control by convenient lever switches facilitates rapid adjustments. Contacts are made of solid silver-alloy; the units of higher resistance value are wound with Evanohm* wire, the units of lower resistance value with Manganin** wire. Both models of the GR 1436 are available without cabinets for custom installations; inquiries are invited. Physical size of the new units is 8-1/2 X 3-7/8 X 8-5/16 in. (220 X 99 X 213 mm). The new resistors were developed by W. J. Bastanier, development engineer in the GR Component and Network Testing Group.

*Registered trademark of Wilbur B. Driver Co.
**Registered trademark of Driver-Harris Co.

NEW



The introduction of new coaxial capacitance standards GR 1405-A (20 pF) and GR 1405-B (10 pF) extends the existing GR line of coaxial capacitance standards. Now available are units ranging from 1 pF to 20 pF, terminated in the GR900[®] precision connector. Development of the new capacitance standards was the responsibility of J. Zorzy, Group Leader of the GR Microwave Group.

NEW



The GR 1522-P2 Differential Pre-amplifier provides for operation of the GR 1522 Recorder from ungrounded signal sources. Its differential input will handle a wide range of voltage and current measurements. Common-mode rejection up to 180 dB is a feature at inputs up to 500 volts. The preamplifier was developed by J. M. Steele, development engineer in the GR Acoustics/Signal Analysis Group.

Complete specifications for the above units appear in Catalog U, available shortly.

Catalog Number	Description	Price in USA
1436-9700	1436-M Decade Resistor, 111,110 Ω	Bench Model
1436-9701		Rack Model
1436-9702	1436-P Decade Resistor, 1,111,100 Ω	Bench Model
1436-9703		Rack Model
1405-9704	1405-A Coaxial Capacitance Standard, 20 pF	85.00
1405-9703	1405-B Coaxial Capacitance Standard, 10 pF	85.00
1522-9602	1522-P2 Differential Pre-amplifier	475.00

All prices subject to quantity discount.

GENERAL RADIO

WEST CONCORD, MASSACHUSETTS 01781
617 369-4400

SALES AND SERVICE

ALBUQUERQUE	505 265-1097	DAYTON	513 434-6979	*LOS ANGELES	714 540-9830
ANCHORAGE	907 279-5741	DENVER	303 447-9225	*NEW YORK (NY)	212 964-2722
ATLANTA	404 633-6183	DETROIT	313 261-1750	(NJ)	201 943-3140
BOLTON	617 779-5562	GREENSBORO	919 288-4316	PHILADELPHIA	215 646-8030
BOSTON	617 646-0550	GROTON	203 445-8445	ROCHESTER	315 454-9323
BRIDGEPORT	203 377-0165	HARTFORD	203 658-2496	SAN DIEGO	714 540-9830
BURBANK	714 540-9830	HOUSTON	713 464-5112	*SAN FRANCISCO	415 948-8233
*CHICAGO	312 992-0800	HUNTSVILLE	800 241-5122	SEATTLE	206 747-9190
*CLEVELAND	216 886-0150	INDIANAPOLIS	317 636-3907	SYRACUSE	315 454-9323
*COCOA BEACH	800 241-5122	LONG ISLAND	201 934-3140	*WASHINGTON,	
*DALLAS	214 637-2240			BALTIMORE	301 881-5333

INTERNATIONAL DIVISION

WEST CONCORD, MASSACHUSETTS 01781, USA

*ARGENTINE and PARAGUAY Cosin S.A. Buenos Aires	HONG KONG and MACAU Gilman & Co., Ltd. Hong Kong, B.C.C.	PERU Importaciones y Representaciones Electronicas S.A. Lima	*GENERAL RADIO COMPANY (OVERSEAS) P.O. Box 124, CH-8034, Zürich, Switzerland		
*AUSTRALIA Warburton Frankl Industries Pty. Ltd. Sydney, Melbourne, Brisbane, Adelaide	INDIA Motwane Private Limited Bombay, Calcutta, Lucknow, Kanpur, New Delhi, Bangalore, Madras	PHILIPPINES T. J. Wolff & Company Makati, Rizal	AUSTRIA Dipl. Ing. Peter Marchetti Wien	*FRANCE General Radio France Paris, Lyon	REPUBLIC OF SOUTH AFRICA G. H. Langier & Co., Ltd. Johannesburg
*BRAZIL Ambriex S.A. Rio de Janeiro São Paulo	*JAPAN Midoriya Electric Co., Ltd. Tokyo	SINGAPORE Vanguard Company Singapore	BELGIUM Groenpol Belgique S. A. Bruxelles	*GERMANY General Radio GmbH München, Hamburg	SPAIN Hispano Electronica S.A. Madrid
*CANADA — General Radio Canada Limited Toronto, Montreal, Ottawa	KOREA M.C International San Francisco, Seoul	TAIWAN Heighen Trading Co., Ltd. Taipei	DEMOCRATIC REPUBLIC OF THE CONGO Desco de Schulthess Zürich	GREECE Marios Dalleggio Representations Athens	SWEDEN Firma Johan Lagercrantz KB Solna
CHILE Cosin Chile Ltda. Santiago	MALAYSIA Vanguard Company Kuala Lumpur	THAILAND G. Simon Radio Company Ltd. Bangkok	DENMARK SEMCO Senter & Co. København	ISRAEL Eastronics Ltd. Tel Aviv	SWITZERLAND Seyffer & Co. A.G. Zürich
COLOMBIA Manuel Trujillo Venegas e Hijo, Ltda. Bogota 2, D. E.	*MEXICO Electronica Fredin S.A. Mexico, T.O.D.F.	URUGUAY Cosin Uruguay S.A. Montevideo	EASTERN EUROPE General Radio Company (Overseas)	*ITALY General Radio Italia S.p.A. Milano	TURKEY Mevag Engineering, Trading and Industrial Corporation Istanbul
ECUADOR Suministros Technicos Ltda. Guayaquil	*NEW ZEALAND W. & K. McLean Limited Auckland, Wellington	VENEZUELA Cosin C. A. Caracas	EIRE General Radio Company (Overseas)	NETHERLANDS Groenpol Industriële Verkoop N.V. Amsterdam	*UNITED KINGDOM General Radio Company (U.K.) Limited Bourne End, Buckinghamshire
	PAKISTAN Pak Land Corporation Karachi		FINLAND Into O/Y Helsinki	NORWAY Gustav A. Ring A/S Oslo	YUGOSLAVIA General Radio Company (Overseas)
				PORTUGAL Casa Serras Lisboa	

*Repair services are available at these offices.

GENERAL RADIO

Experimenter

WEST CONCORD, MASSACHUSETTS 01781

Do we have your correct name and address—name, company or organization, department, street or P.O. box, city, state, and zip code? If not, please clip the address label on this issue and return it to us with corrections or, if you prefer, write us; a postcard will do.

PRINTED
IN
U.S.A.



IET LABS, INC in the GenRad tradition
534 Main Street, Westbury, NY 11590

www.ietlabs.com
TEL: (516) 334-5959 • (800) 899-8438 • FAX: (516) 334-5988